

# Modular Language Engineering

Rafael Ugaz, Sadaf Mustafiz, Cláudio Gomes, Bruno Barroca, Hans Vangheluwe

# Heterogeneity in Languages

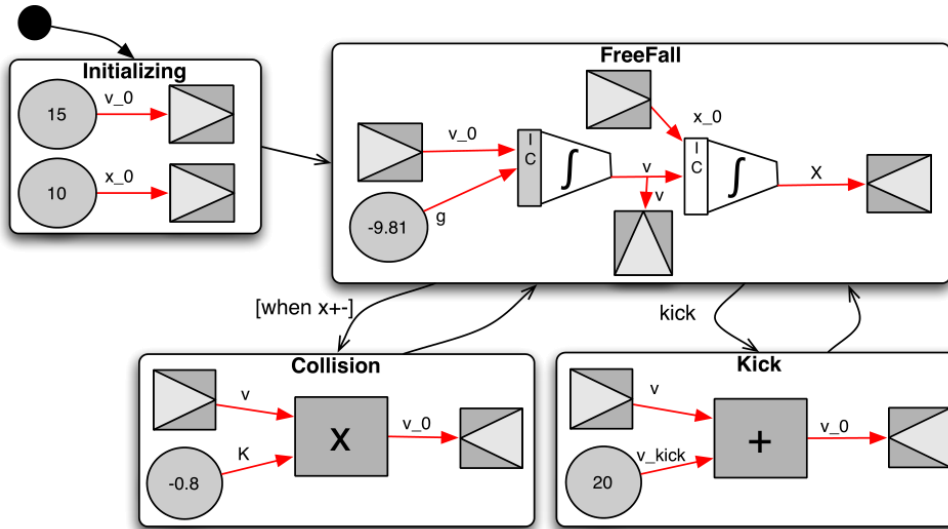

Control Logic (FSAs)

Motor and window mechanics (ODEs)

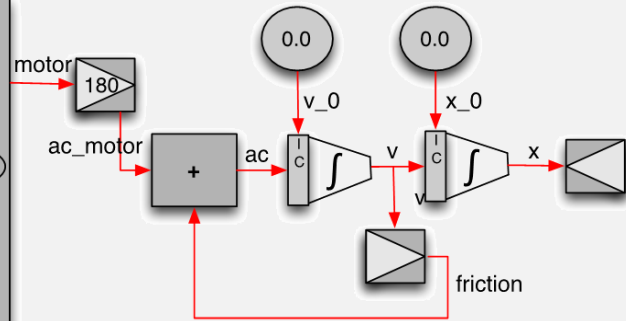
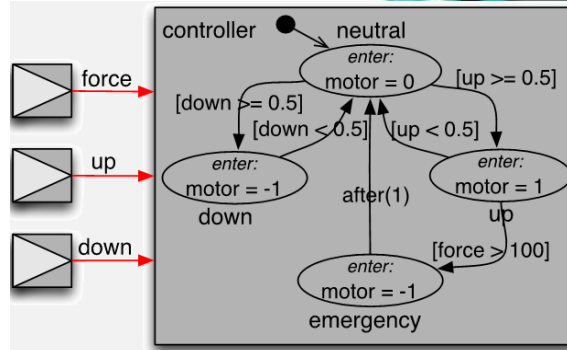
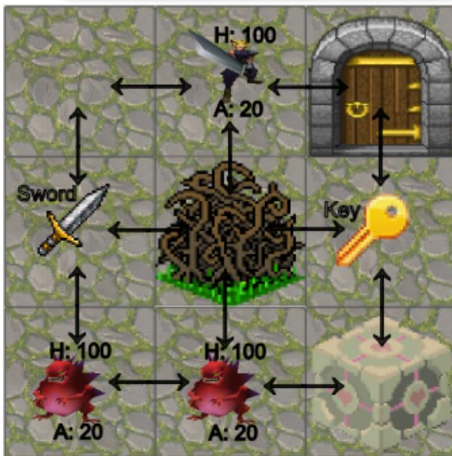

# De-constructing an Hybrid Language

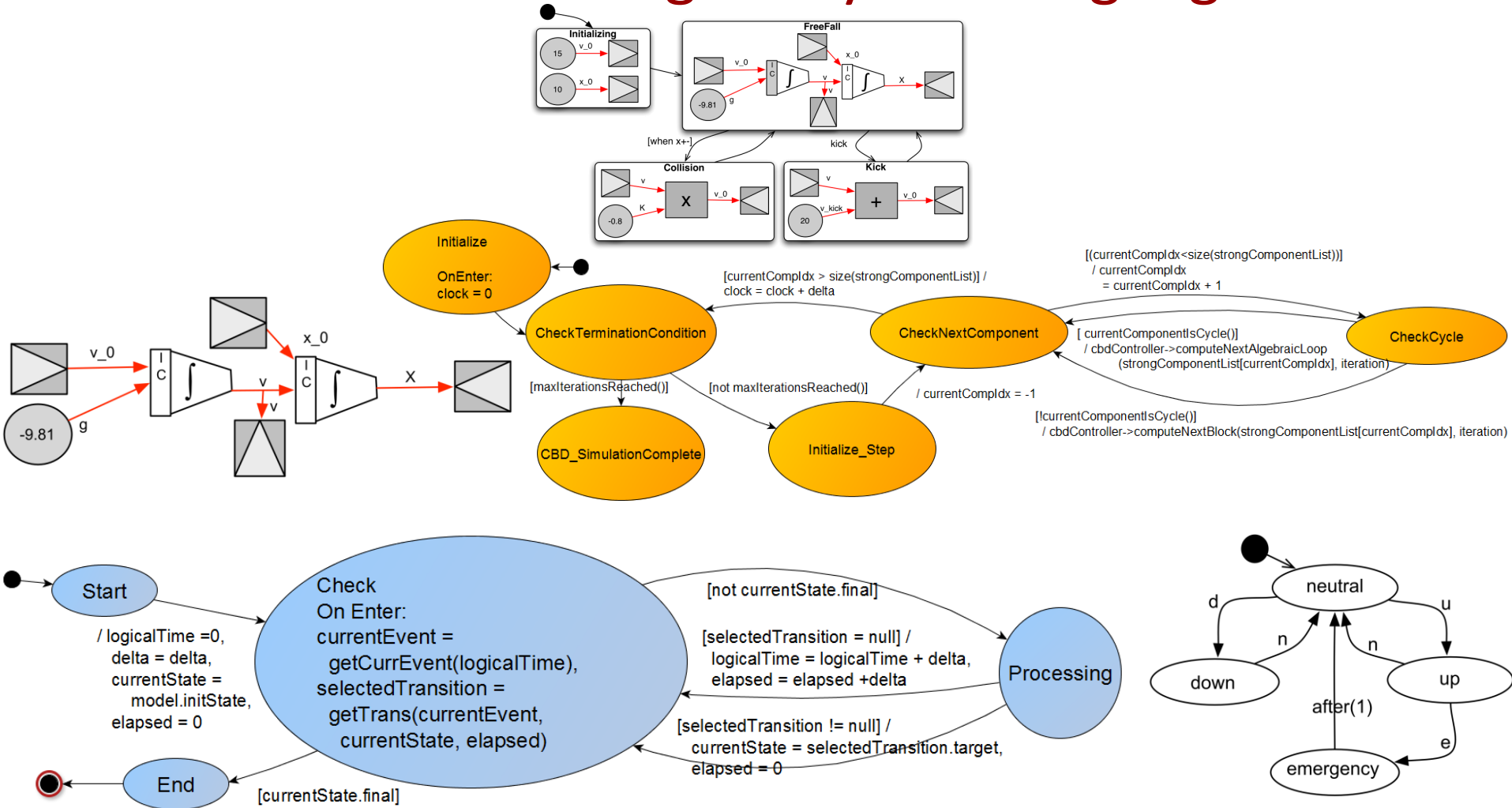

# Language Specification Fragments (LSF)

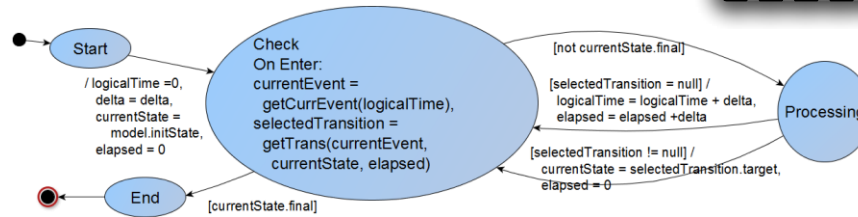
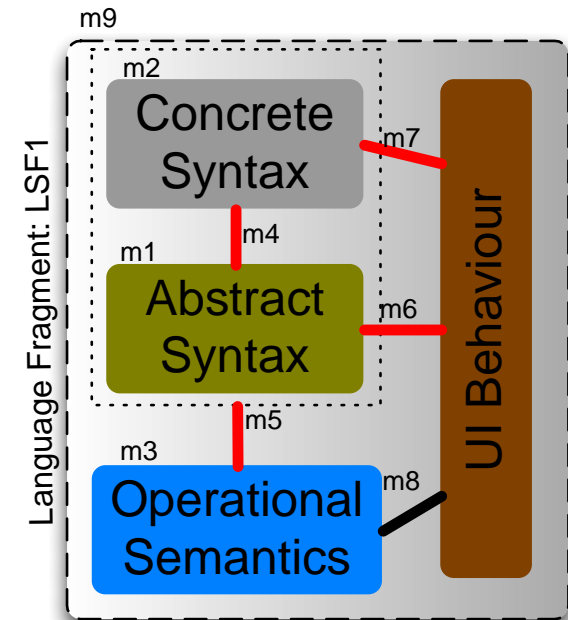
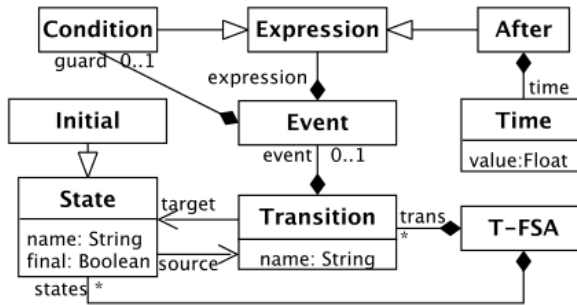
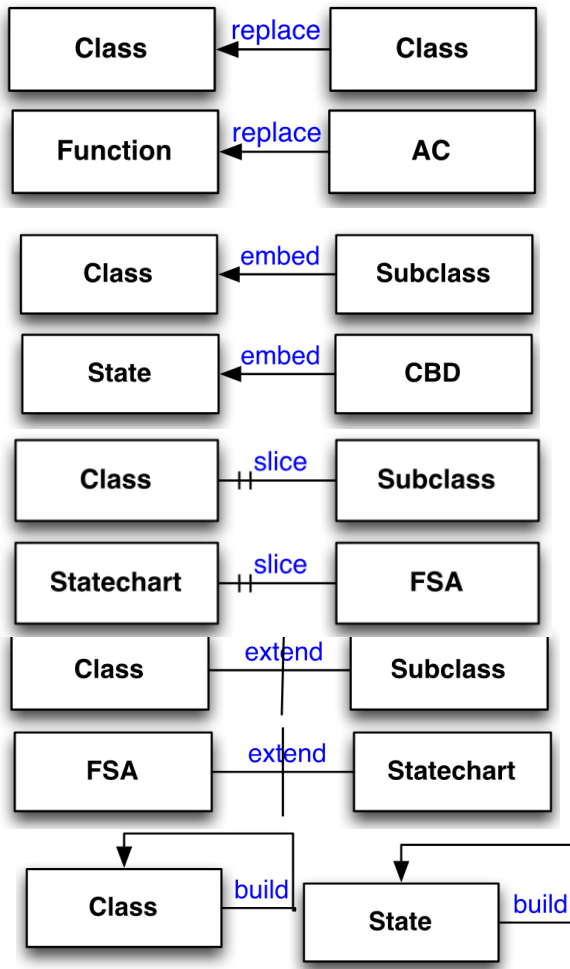

# Constructing an Hybrid Language

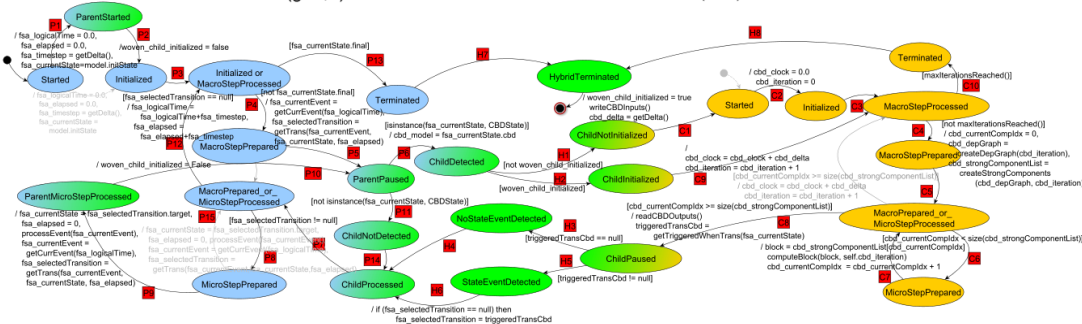
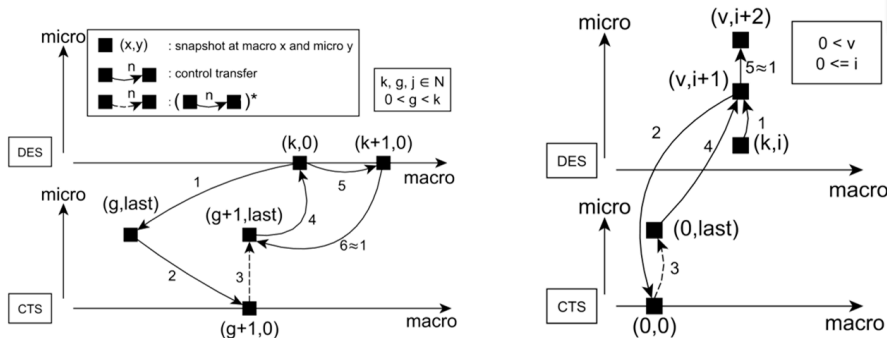
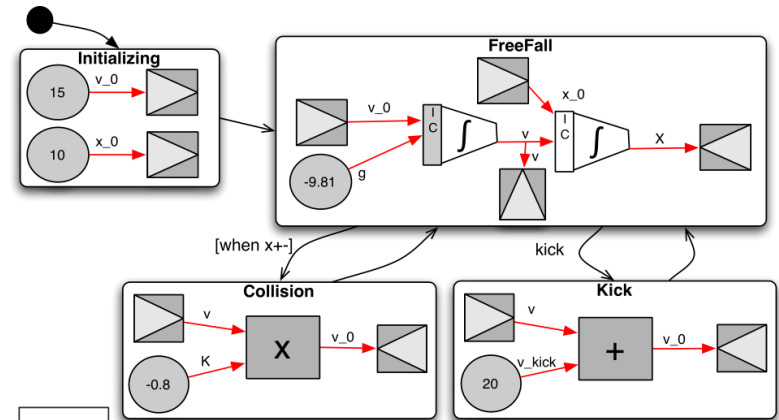
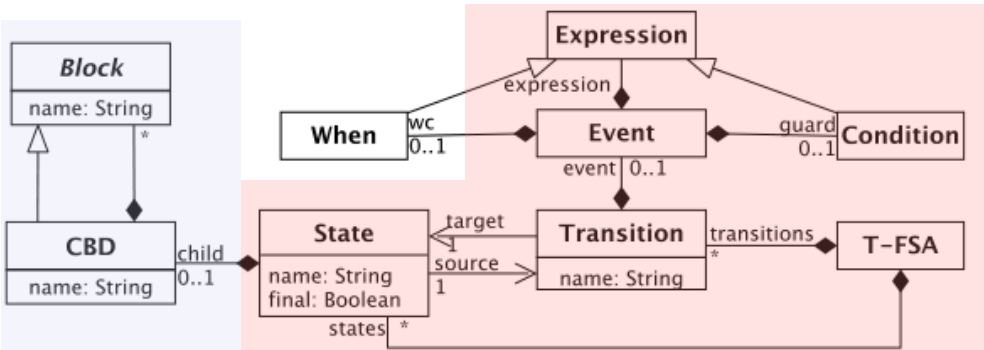

# The Big Picture

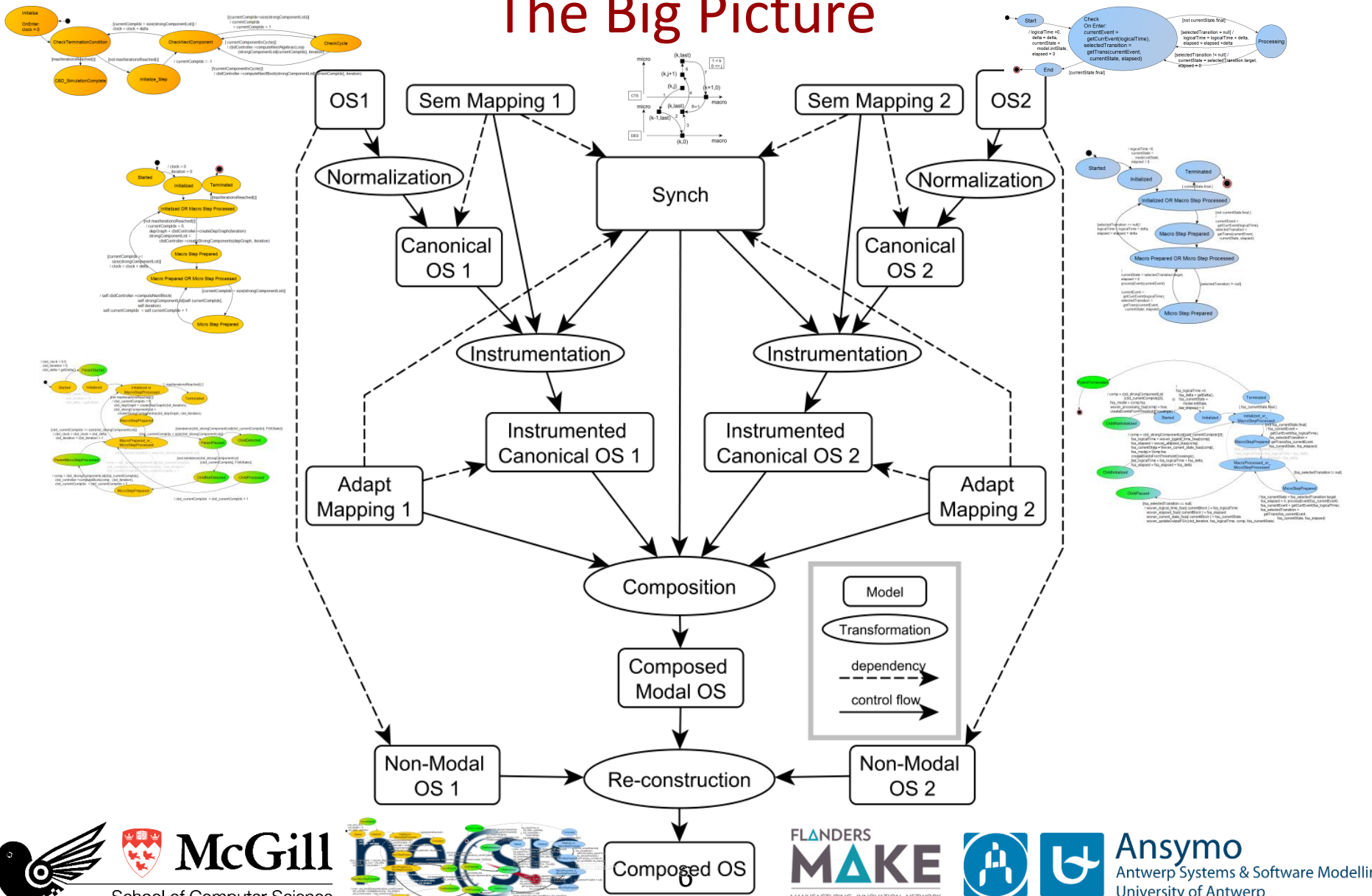

# Thank you!

- Ugaz, Rafael. Weaving of domain-specific languages: A literature review. 2014.
- Ugaz, Rafael. Weaving of domain-specific languages: Enabling technology. 2014.
- Ugaz, Rafael. Combination of Domain-Specific Languages. 2015.
- Amalio, N., de Lara, J., and Guerra, E. Fragmenta: A theory of fragmentation for MDE. In Model Driven Engineering Languages and Systems (MODELS), 2015 ACM/IEEE 18th International Conference on (2015), 106–115.
- Denil, J., Meyers, B., Denil, J., Meyers, B., Meulenaere, P. De, & Vangheluwe, H. (2015). Explicit Semantic Adaptation of Hybrid Formalisms for FMI Co-Simulation. In Society for Computer Simulation International (Ed.), *Proceedings of the Symposium on Theory of Modeling & Simulation: DEVS Integrative M&S Symposium* (pp. 99–106). Alexandria, Virginia.
- Mustafiz, S., Barroca, B., Gomes, C., & Vangheluwe, H. (2016). Towards Modular Language Design Using Language Fragments: The Hybrid Systems Case Study. In *Information Technology - New Generations (ITNG), 2016 13th International Conference on* (pp. 785–797). [http://doi.org/10.1007/978-3-319-32467-8\\_68](http://doi.org/10.1007/978-3-319-32467-8_68)
- Mustafiz, S., Gomes, C., Barroca, B., & Vangheluwe, H. (2016) Explicit Modelling of Semantic Adaptation for Hybrid Systems using Modular Language Design. In *Proceedings of the Symposium on Theory of Modeling & Simulation: DEVS Integrative M&S Symposium* (p. to appear). Pasadena, CA, USA